

番号 NO	名称 DESCRIPTION	寸法 DIMENTION	材料 MATERIAL	個数 QTY.	摘要 REMARKS
1

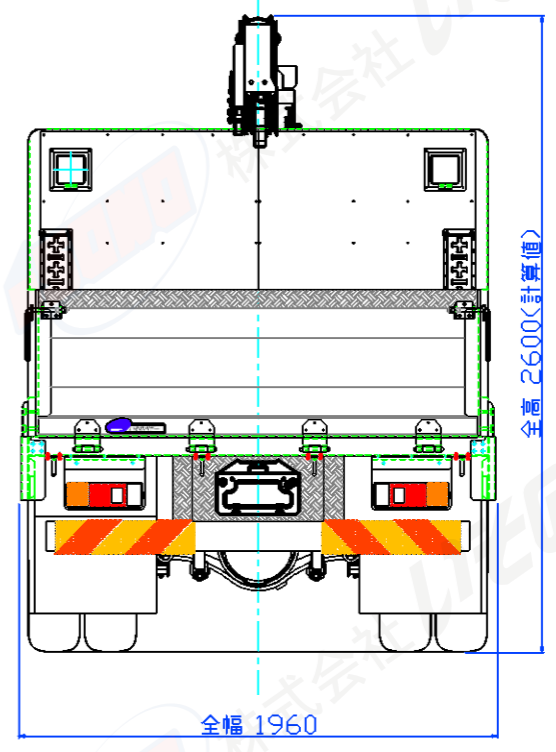
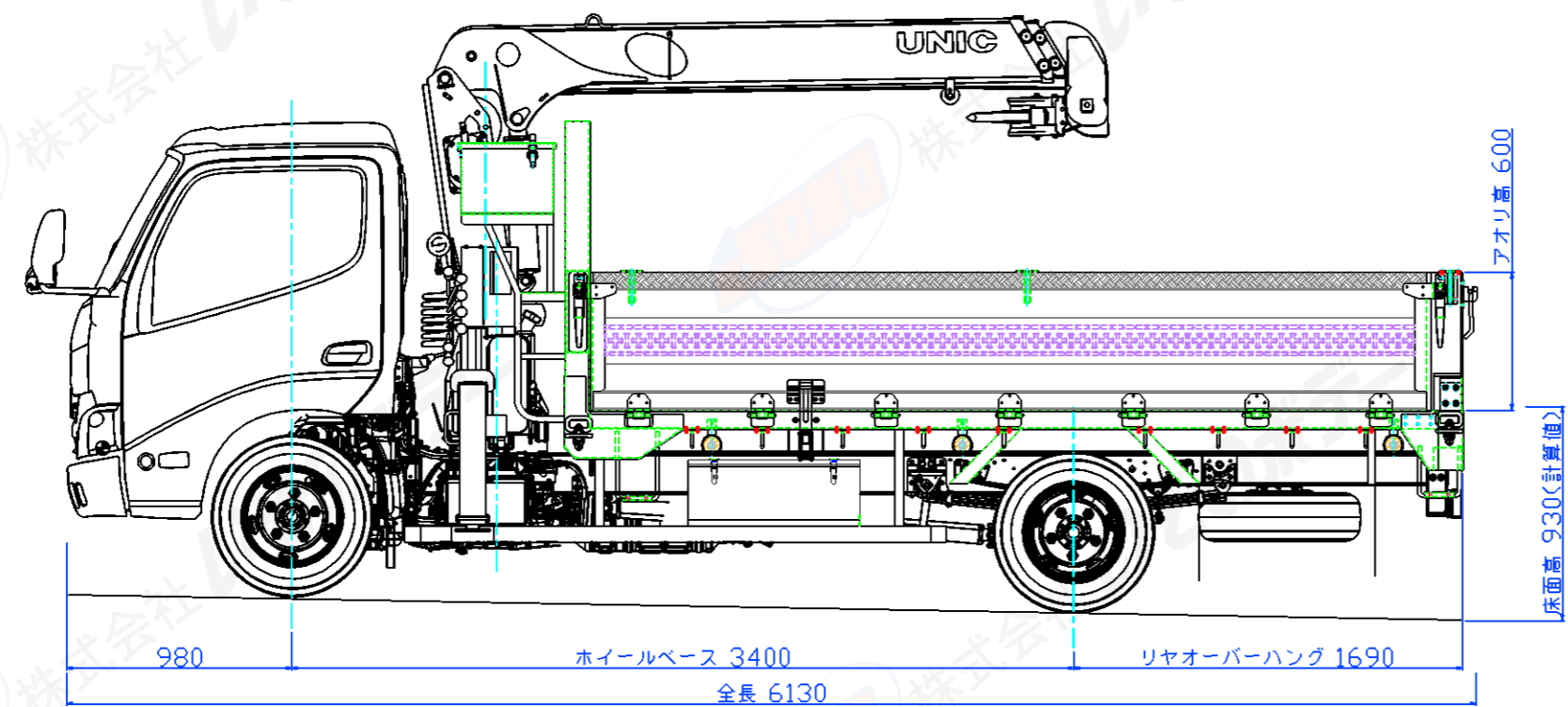
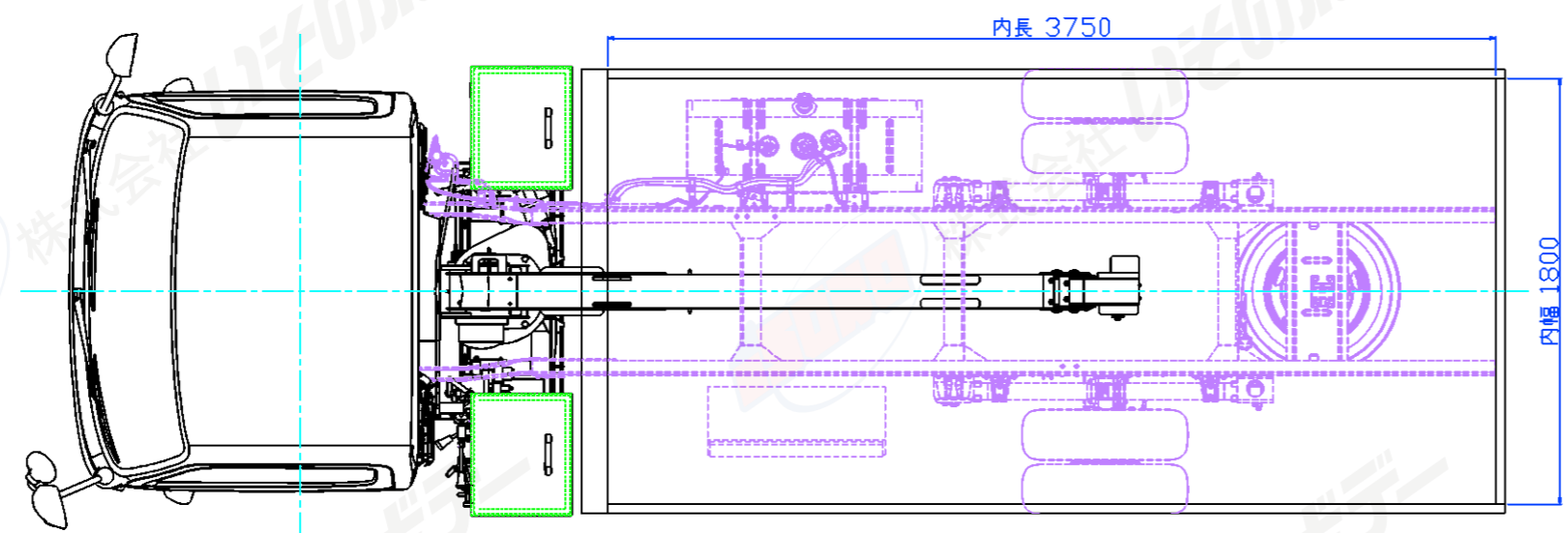

承認 APPROVED	審査 CHECKED	設計 DESIGN

図名 TITLE	外観三面図		図番 DWG.No
尺度 SCALE	1:30	単位 UNITS	mm
		画法 ANGLE	

△	改	訂	日付	承認	審査	担当
	1			2		

株式会社 いそのボデー
isono body INC.